



**EFFECTIVE FROM
JANUARY 2024**

EXPORT CATALOGUE

BRAVO LINE

**TYRE CHANGERS & WHEEL BALANCER
AND ORIGINAL ACCESSORIES**

REL. MAY 2024

COLOR TABLE

1) The standard company colour of our equipment is WINDOW GREY RAL 7040 (→ /39).

2) On demand other colours are available (see RAL table)*

• Below the table for the colors:

	→ /25 RAL 5015 Blue sky
	→ /A4 RAL 5011 Blue (Peugeot)
	→ /22 RAL 5011 Blue (Peugeot) orange-peel
	→ /16 RAL 3002 Red
	→ /45 RAL 1003 Yellow (Renault)
	→ /38 RAL 7042 Grey (Renault)
	→ /39 RAL 7040 Window grey (Volkswagen / Porsche / Fiat)
	→ /33 RAL 7011 Grey (Mercedes)
	→ /65 RAL 7012 Grey (Mercedes)
	→ /52 RAL 7015 Grey (Mercedes)
	→ /69 RAL 7030 Stone grey (Ferrari / Maserati)
	→ /34 RAL 7016 Anthracite grey (BMW)

• Different colors subject to confirmation of the Export dept.

* : The equipment in different color than standard can be subject to surcharge.

The pictures included in the present illustrated catalogue, are only intended to show the product and are therefore not binding. The company reserves the right to make in every moment and without prior notice, any modification deemed necessary.

NEXION S.p.A. declines any responsibility for any complaint coming from the use of not original accessories or spares with consequent forfeiture of the CE conformity declaration.

TABLE OF CONTENTS

PASSENGER CAR TYRE CHANGERS	4
M 54 LL	4
M 54	6
M 51	8
M 34	10
M 31	11
OPTIONAL ACCESSORIES FOR M 54 AND M 51 series	13
OPTIONAL ACCESSORIES FOR M 34 AND M 31	14
OPTIONAL ACCESSORIES FOR PASSENGER CAR TYRE CHANGERS	15
HEAVY-DUTY TYRE CHANGERS	19
F 440	19
F 426	20
OPTIONAL ACCESSORIES FOR F 440 AND F 426	21
TRUCK WHEEL BALANCERS	23
B 75 TRUCK	23
OPTIONAL ACCESSORIES FOR B 75 TRUCK	24
LIGHT VEHICLE WHEEL BALANCERS	26
B 55	26
B 60	27
OPTIONAL ACCESSORIES FOR B 55 AND B 60	28
DIAGRAM OF PACKING SPECIFICATION	32
GENERAL SALE CONDITIONS	33

PASSENGER CAR TYRE CHANGERS



M 54 LL series



HTB24 Helper optional



- All models supplied with:
- Bead protection plastic lever.
 - Plastic rim protections.
 - Bead clamp
 - Set of 4 jaw pads for alloy rims
 - Plastic cover for bead breaker blade
 - Set of plastic inserts for tool head
 - Tyre paste container
 - Support for tyre paste container
 - Brush
 - Operator's manual

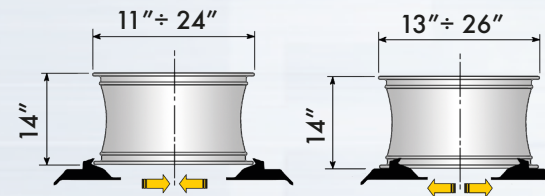

M 54 LL

PN	Power Supply	Description
0-11901731/25	400V/3Ph/50Hz	M 54 LL 2V FS
0-11901721/25	400V/3Ph/50Hz	M 54 LL 2V
0-11901711/25	400V/3Ph/50Hz	M 54 LL FS
0-11901732/25	200÷230V/1Ph/50Hz	M 54 LL FS



: New or Modified Item

PN	Power Supply	Description
0-11901742/25	200÷230V/1Ph/60Hz	M 54 LL FS
0-11901751/25	200÷230V/3Ph/60Hz	M 54 LL FS
0-11901704/25	100÷115V/1Ph/60Hz	M 54 LL FS
0-11901701/25	400V/3Ph/50Hz	M 54 LL
0-11901712/25	200÷230V/1Ph/50Hz	M 54 LL
0-11901722/25	200÷230V/1Ph/60Hz	M 54 LL
8-11220014		Customization kit - M 54 LL



Bravo
LINE

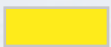

: New or Modified Item

PASSENGER CAR TYRE CHANGERS



M 54 series



HTB24 Helper optional



- All models supplied with:
- 1 Bead lever + plastic cover
 - 1 Set of 4 jaw pads for alloy rims
 - 1 Plastic cover for bead breaker blade
 - 1 Set of plastic inserts for tool head
 - 1 Tyre paste container
 - 1 Support for tyre paste container
 - 1 Brush
 - 1 Operator's manual

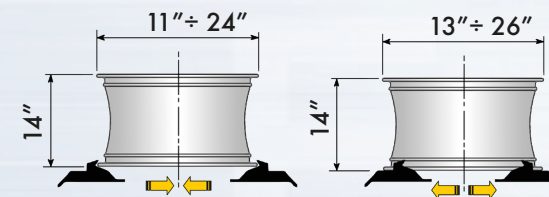

M 54

PN	Power Supply	Description
0-11901331/25	400V/3Ph/50Hz	M 54 2V FS
0-11901321/25	400V/3Ph/50Hz	M 54 2V
0-11901311/25	400V/3Ph/50Hz	M 54 FS
0-11901332/25	200-230V/1Ph/50Hz	M 54 FS



: New or Modified Item

PN	Power Supply	Description
0-11901342/25	200-230V/1Ph/60Hz	M 54 FS
0-11901351/25	200-230V/3Ph/60Hz	M 54 FS
0-11901304/25	100-115V/1Ph/60Hz	M 54 FS
0-11901301/25	400V/3Ph/50Hz	M 54
0-11901312/25	200-230V/1Ph/50Hz	M 54
0-11901322/25	200-230V/1Ph/60Hz	M 54
8-11220010		Customization kit for M 54

PASSENGER CAR TYRE CHANGERS



M 51 series



HTB21 Helper optional



- All models supplied with:
- 1 Bead lever + plastic cover
 - 1 Set of 4 jaw pads for alloy rims
 - 1 Plastic cover for bead breaker blade
 - 1 Set of plastic inserts for tool head
 - 1 Tyre paste container
 - 1 Support for tyre paste container
 - 1 Brush
 - 1 Operator's manual

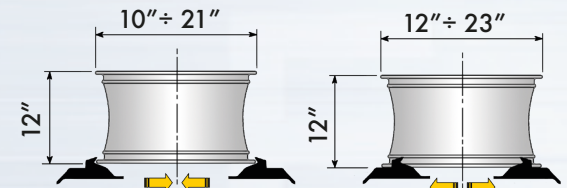

M 51

PN	Power Supply	Description
0-11901431/25	400V/3Ph/50Hz	M 51 2V FS
0-11901421/25	400V/3Ph/50Hz	M 51 2V
0-11901411/25	400V/3Ph/50Hz	M 51 FS
0-11901432/25	200-230V/1Ph/50Hz	M 51 FS



Bravo
LINE

: New or Modified Item

PN	Power Supply	Description
0-11901442/25	200-230V/1Ph/60Hz	M 51 FS
0-11901441/25	200-230V/3Ph/60Hz	M 51 FS
0-11901404/25	100-115V/1Ph/60Hz	M 51 FS
0-11901401/25	400V/3Ph/50Hz	M 51
0-11901412/25	200-230V/1Ph/50Hz	M 51
0-11901422/25	200-230V/1Ph/60Hz	M 51
8-11220011		Customization kit for M 51



Bravo
LINE



: New or Modified Item

PASSENGER CAR TYRE CHANGERS



M 34

HSU24 Helper optional



- All models supplied with:
- 1 Bead lever + plastic cover
 - 1 Set of 4 jaw pads for alloy rims
 - 1 Plastic cover for bead breaker blade
 - 1 Set of plastic inserts for tool head
 - 1 Tyre paste container
 - 1 Support for tyre paste container
 - 1 Inflating gun and 1 Tank manometer
 - 1 Brush
 - 1 Operator's manual

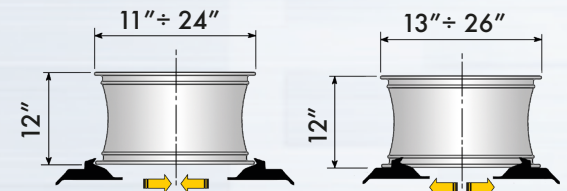

M 34

PN	Power Supply	Description
0-11901604/25	100-115V/1Ph/60Hz	M 34
8-11220013		Customization kit for M 34



Bravo
LINE

: New or Modified Item

PASSENGER CAR TYRE CHANGERS



M 31



HSA21 Helper optional



- All models supplied with:
- 1 Bead lever + plastic cover
 - 1 Set of 4 jaw pads for alloy rims
 - 1 Plastic cover for bead breaker blade
 - 1 Set of plastic inserts for tool head
 - 1 Tyre paste container
 - 1 Support for tyre paste container
 - 1 Brush
 - 1 Operator's manual

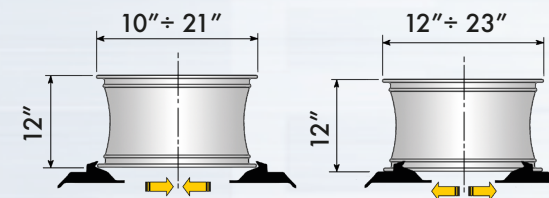

M 31

PN	Power Supply	Description
0-11901501/25	400V/3Ph/50Hz	M 31
0-11901511/25	200-230V/3Ph/50Hz	M 31
0-11901521/25	200-230V/3Ph/60Hz	M 31



: New or Modified Item

PN	Power Supply	Description
0-11901512/25	200-230V/1Ph/50Hz	M 31
0-11901522/25	200-230V/1Ph/60Hz	M 31
8-11220012		Customization kit for M 31

OPTIONAL ACCESSORIES FOR M 54 AND M 51 SERIES

PN	Picture	Description		M 54 LL series	M 54 series	M 51 series
8-11900260		<p>HTB24 Bead lifting/pressing multipurpose device.</p>		●	●	
8-11900261		<p>HTB21 Bead lifting/pressing multipurpose device.</p>		●	●	●



OPTIONAL ACCESSORIES FOR M 34 AND M 31

PN	Picture	Description		M 34	M 31
8-11900263		HSU24 Bead pressing device.		●	
8-11900262		HSA 21 Bead pressing device.			●

OPTIONAL ACCESSORIES FOR PASSENGER CAR TYRE CHANGERS

PN	Picture	Description	M 54LL 2V - M 54LL	M 54LL FS	M 54 2V - M 54	M 54 FS	M 51 2V - M 51	M 51 FS	M 34	M 31
8-11120075		FWL 65 Wheel lifter	●	●	●	●	●	●	●	
CT-S-0600000		WRSB Wheel support rotation base	●	●	●	●	●	●	●	●
8-11100362		PGA Tyre inflating gun with BAR scale (EC approved).	●		●		●			●
CT-S-0200000		Universal bead clamp.	●	●	●	●	●	●	●	●
CT-S-0110000		Quick release device for demounting tool.			●	●	●	●	●	●

OPTIONAL ACCESSORIES FOR PASSENGER CAR TYRE CHANGERS

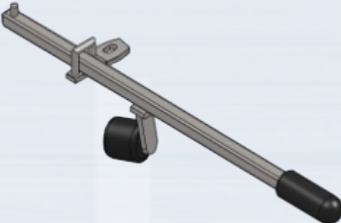
PN	Picture	Description	M 54LL 2V - M 54LL	M 54LL FS	M 54 2V - M 54	M 54 FS	M 51 2V - M 51	M 51 FS	M 34	M 31
CT-S-0120000		Plastic demount head assy.							●	●
CT-S-0310000		Plastic demount head assy.			●	●	●	●		
C-21-8000100		Motorcycle demounting head			●	●	●	●	●	●
CT-S-0500000		Tyre pressing assist device.	●	●	●	●	●	●	●	●

OPTIONAL ACCESSORIES FOR PASSENGER CAR TYRE CHANGERS

PN	Picture	Description	Price €	M 54LL 2V - M 54LL	M 54LL FS	M 54 2V - M 54	M 54 FS	M 51 2V - M 51	M 51 FS	M 34	M 31
C-M-0200000		Motorcycle adaptors kit for inner adjustable jaws (11"-26") 4pcs		●	●	●	●			●	
C-M-0200000A		Motorcycle adaptors kit for inner adjustable jaws (8"-23") 4pcs						●	●		●
C-M-0300000		4 Motorcycle adaptors for high profile rim with spokes (for ex. BMW-Ducati) - (11"-26")		●	●	●	●			●	
C-M-0400000		4 Motorcycle adaptors for high profile rim with spokes (for ex. BMW-Ducati) - (8"-23")						●	●		●
8-11900272		Plastic protections kit for motorcycle adapter, 4+4 pcs		●	●	●	●	●	●	●	●
C-54-8000019		Plastic cover for bead lever.				●	●	●	●	●	●
8-11900270		21" and 24" CW plastic protection kit.				●	●	●	●	●	●

OPTIONAL ACCESSORIES FOR PASSENGER CAR TYRE CHANGERS

PN	Picture	Description	Price €	M 54LL 2V - M 54LL	M 54LL FS	M 54 2V - M 54	M 54 FS	M 51 2V - M 51	M 51 FS	M 34	M 31
8-11900271		Plastic protections kit for cover and lever		●	●	●	●	●	●	●	●
8-11900265		JAW COVER FOR ADJUSTABLE SYSTEM 24" YELLOW (N° 4 PIECES)		●	●	●	●			●	
8-11900266		DEMOUNT HEAD PROTECTION COVER YELLOW (N° 4 PIECES)				●	●	●	●	●	●
8-11900267		DEMOUNT TAIL PROTECTION COVER YELLOW (N° 4 PIECES)				●	●	●	●	●	●
8-11900268		JAW COVER TB 21" YELLOW (N° 4 PIECES)						●	●		●
8-11120081		Protection kit for LL tool head		●	●						

HEAVY-DUTY TYRE CHANGERS



F 440



- Supplied with:
- 1 Bead lifting lever
 - 1 Rim ring lever
 - 1 Rim clamp
 - 1 Set of 4 extensions for jaw from 40" to 56"
 - 1 Operator's manual

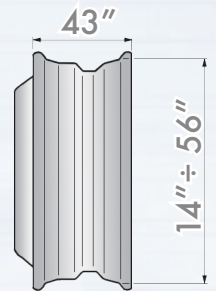

* with extensions

F 440

PN	Power Supply	Description
0-12104301/39	400V/3Ph/50Hz	F 440 RAL 7040 Grey
0-12104302/39	230V/3Ph/60Hz	F 440 RAL 7040 Grey
0-12104303/39	400V/3Ph/60Hz	F 440 RAL 7040 Grey
8-12120014		Customization kit for F 440



Bravo
LINE

: New or Modified Item

HEAVY-DUTY TYRE CHANGERS



F 426



- All models supplied with:
- 1 Bead lifting lever
 - 1 Rim lever
 - 1 Rim clamp
 - 1 Set of 4 jaws for alloy rims
 - 1 Operator's manual

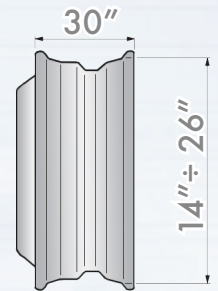

F 426

PN	Power Supply	Description
0-12102101/39	400V/3Ph/50Hz	F 426 RAL 7040 Grey
0-12102102/39	230V/3Ph/60Hz	F 426 RAL 7040 Grey
0-12102103/39	230V/1Ph/60Hz	F 426 RAL 7040 Grey
0-12102104/39	230V/1Ph/50Hz	F 426 RAL 7040 Grey
8-12100146		Customization kit for F 426





Bravo
LINE

: New or Modified Item

OPTIONAL ACCESSORIES FOR F 440 AND F 426

PN	Picture	Description
8-12120019		CGL56 Set of 4 clamps for alloy rims for F 440.
8-12100045		Inserts kit for CGL56 alloy wheel protections (for F 440)
801271597		MV50/2 Pair of bead clamps
801227195		PL56 Clamp for alloy rims.
801217615		LA24 Bead lifting lever.

OPTIONAL ACCESSORIES FOR F 440 AND F 426

PN	Picture	Description
801417620		LC24 Rim ring lever.
8-12100005		AB164 Locking adapter for alloy rims D.164.
8-12100006		AB176 Locking adapter for alloy rims D.176.
8-12100007		AB161 Locking adapter for alloy rims D.161.
8-12100008		AB202 Locking adapter for alloy rims D.202.
8-12300001		AB220 Locking adapter for alloy rims D.220.
8-12100009		AB221 Locking adapter for alloy rims D.221.
8-12100010		AB281 Locking adapter for alloy rims D.281.

TRUCK WHEEL BALANCERS



B 75 TRUCK

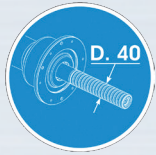

- Model supplied with:
- 1 Caliper
 - 1 Allen wrench CH 12
 - 1 300 gr. weight for self-calibration
 - 1 100 gr. weight for self-calibration
 - 1 Operator's manual
 - 1 Threaded hub and extractor
 - 1 Pliers

Wheel guard and 200 kg wheel lifter included.

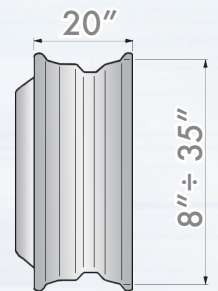

B 75 TRUCK

PN	Power Supply	Description
0-21900026/39	200-230V/1Ph/50-60Hz	B 75 with Inverter Technology System (ITS)
0-21900025/39	100-115V/1Ph/50-60Hz	B 75 with Inverter Technology System (ITS)
8-21900184		Customization kit for B 75









: New or Modified Item

OPTIONAL ACCESSORIES FOR B 75 TRUCK

PN	Picture	Description
8-21900187/39		CCKT Color identity panel. The CCKT Kit can be purchased in the following colors: RAL 3002 Red /16  RAL 5002 Blue /20  RAL 5015 Blue Sky /25  RAL 7016 Gray /34  RAL 1007 Yellow /40  RAL 9005 Black /90 
8-21900188		L&L KIT LASER pointer & LED spotlight kit.
8-21900220		ART40 Truck centring flange set. Range: -PCD 5 x 225 - 285.75 - 335 mm. -PCD 4 x 275 - 285 mm.
8-21900193		KCT40 Range 1: 211÷218 mm Range 2: 217÷224 mm Range 3: 277÷285 mm
8-21100261		GGR40 Centering kit diam 40 for central hole wheels 183,5÷223 mm - 17,5"-19.5" rims (IVECO-MAN- DAF)
8-21900189		ARFT40 Range 1: 95÷175 mm Range 2: 120÷133 mm Range 3: 144÷166 mm

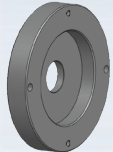
OPTIONAL ACCESSORIES FOR B 75 TRUCK

PN	Picture	Description
8-21900191		ARU40 ø 42÷103,50 mm - recessed spring included
8-21900194		GTV40 Car centering ring nut.
8-21100275		GTR40 EVO - Quick nut Ø 40x4 mm
8-21100276		GTR40 EVO HS - Quick nut Ø 40x4 mm with turning handles
8-21100290		TWS40 Truck wheel spacer Ø 40 (30mm - 1.19")
8-21101402		ACCESSORY RACK

LIGHT VEHICLE WHEEL BALANCERS



B 55

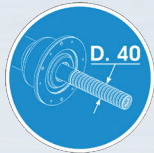

- Supplied with:
- 1 Pliers for attaching balance weights
 - 1 4 cones $\varnothing 42 \div 156$ mm
 - 1 Caliper
 - 1 Threaded hub
 - 1 Wheel fixing ring with spacer cap
 - 1 Wheel fixing cap
 - 1 100 g. weight for self-calibration
 - 1 Operator's manual

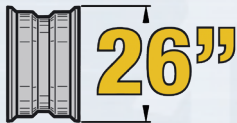

CCK Panel
NOT included



B 55

PN	Power Supply	Description
0-21900036/39	200÷230V/1Ph/50-60Hz	B55 AD - Display wheel balancer with AUTOSEL function for automatic data input (distance & diameter 26"), automatic balancing with brake at the end of the electronic cycle, (wheel guard included, centering and locking kit included)
0-21900034/39	100÷115V/1Ph/50-60Hz	B55 AD - As above but with different power supply
0-21900044/39	200÷230V/1Ph/50-60Hz	B55 AD NO WHEEL GUARD - Display wheel balancer with AUTOSEL function for automatic data input (distance & diameter 26"), automatic balancing with brake at the end of the electronic cycle (wheel guard NOT included, centering and locking kit included)- NO CE
0-21900040/39	100÷115V/1Ph/50-60Hz	B55 AD NO WHEEL GUARD - As above but with different power supply - NO CE
0-21900035/39	200÷230V/1Ph/50-60Hz	B55 M - Display wheel balancer with manual data input, automatic balancing with brake at the end of the electronic cycle (wheel guard included, centering and locking kit included)
0-21900033/39	100÷115V/1Ph/50-60Hz	B55 M - As above but with different power supply
0-21900039/39	100÷115V/1Ph/50-60Hz	B55 M NO WHEEL GUARD - Display wheel balancer with manual data input, automatic balancing with brake at the end of the electronic cycle (wheel guard NOT included, centering and locking kit included) - NO CE
8-21900203		Customization kit - Bravoline 55

LIGHT VEHICLE WHEEL BALANCERS



B 60

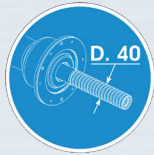

Supplied with:

- 1 Pliers for attaching balance weights
- 1 4 cones $\varnothing 42 \div 156$ mm
- 1 Caliper
- 1 Threaded hub
- 1 Wheel fixing ring with spacer cap
- 1 Wheel fixing cap
- 1 100 g. weight for self-calibration
- 1 Operator's manual

Monitor
NOT included











CCK Panel
NOT included



B 60

PN	Power Supply	Description
0-21900038/39	200÷230V/1Ph/50-60Hz	B60 AD - Monitor wheel balancer with AUTOSEL function for automatic data input (distance & diameter 26"), automatic balancing with brake at the end of the electronic cycle (wheel guard included, centering and locking kit included, monitor NOT included)
0-21900037/39	100÷115V/1Ph/50-60Hz	B60 AD - As above but with different power supply
8-21900215		Customization kit - Bravoline 60

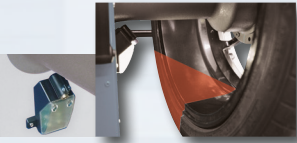

OPTIONAL ACCESSORIES FOR B 55 AND B 60

PN	Picture	Description	B 55 M	B 55 AD	B 60 AD
8-21900206/25	 <p>cck</p>	CCK Color identity panel: RAL 5015 Sky blue. 	●	●	●
8-21900206/20		CCK Color identity panel: RAL 5002 Blue. 	●	●	●
8-21900206/16		CCK Color identity panel: RAL 3002 Red. 	●	●	●
8-21900206/45		CCK Color identity panel: RAL 1003 Yellow 	●	●	●
8-21900207		PB NS Pedal hold brake	●	●	●
8-21900209		TCE40 EVO External width detector (only for automatic data input versions)		●	●
8-21100238		L&L Kit - LASER pointer & LED spotlight kit	●	●	●
8-21900211		WG - Wheel guard kit, only for B55 versions without wheel guard included	●	●	

OPTIONAL ACCESSORIES FOR B 55 AND B 60

PN	Picture	Description	B 55 M	B 55 AD	B 60 AD
8-21100235		19" Widescreen LCD monitor.			●
8-21100141	 DX1 CF1 CF2	DX/CBF Centering accessory for vans and off-road vehicles. Comprising: PN DX1 Spacer 4-107426 CF1 Cone for vans D. 117÷147 mm 4-107423 CF2 Cone for vans D. 143÷173 mm 4-107424	●	●	●
8-21900191		ARU40 ø 42÷103,50 mm - recessed spring included	●	●	●
8-21100082	 B1 B2 B3 B4 B5 B7	SBC Set of 6 wheel centering bushings (min. Ø 54 - max. Ø 75,4 mm). Comprising: PN B1 Bushing D. 56.5 ÷ 57.1 4-105075 B2 Bushing D. 65 ÷ 67 4-105076 B3 Bushing D. 73.2 ÷ 75.4 4-105077 B4 Bushing D. 63.3 ÷ 64,2 4-105078 B5 Bushing D. 58 ÷ 60.1 4-105079 B7 Bushing D. 54÷56,1 4-105080	●	●	●
8-21100089	 ARS DARS	ARS Racing accessory for sport wheels. Comprising: PN ARS Racing spacer 24732 DARS Spacer 30 mm 4-105171	●	●	●

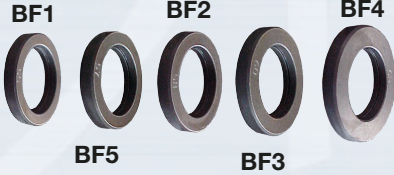
OPTIONAL ACCESSORIES FOR B 55 AND B 60

PN	Picture	Description	B 55 M	B 55 AD	B 60 AD												
8-21100091		<p>FRU-SA D. 40 Universal flange for all wheels with or without central holes.</p> <p>Comprising:</p> <table border="0"> <tr> <td>FT1 Connecting rod with pin</td> <td>PN 2401415</td> </tr> <tr> <td>DEB Conical/spheric fixing wheel nut</td> <td>PN 321878</td> </tr> <tr> <td>CHT6 T exagonal wrench CH 6</td> <td>PN 4-10587</td> </tr> <tr> <td>CHI6 Exagonal wrench CH 6</td> <td>PN 600906</td> </tr> <tr> <td>CEP Exagonal wrench CH22</td> <td>PN 426517</td> </tr> <tr> <td>RFS Holes detector</td> <td>PN 441286</td> </tr> </table>	FT1 Connecting rod with pin	PN 2401415	DEB Conical/spheric fixing wheel nut	PN 321878	CHT6 T exagonal wrench CH 6	PN 4-10587	CHI6 Exagonal wrench CH 6	PN 600906	CEP Exagonal wrench CH22	PN 426517	RFS Holes detector	PN 441286	●	●	●
FT1 Connecting rod with pin	PN 2401415																
DEB Conical/spheric fixing wheel nut	PN 321878																
CHT6 T exagonal wrench CH 6	PN 4-10587																
CHI6 Exagonal wrench CH 6	PN 600906																
CEP Exagonal wrench CH22	PN 426517																
RFS Holes detector	PN 441286																
8-21100092		<p>BVFF Set of 5 bushings for accurate wheel centering on FRU flange.</p> <p>Comprising:</p> <table border="0"> <tr> <td>BF1 Bushing D. 55</td> <td>PN 4-105110</td> </tr> <tr> <td>BF2 Bushing D. 58.1</td> <td>PN 4-105174</td> </tr> <tr> <td>BF3 Bushing D. 60.1</td> <td>PN 4-105175</td> </tr> <tr> <td>BF4 Bushing D. 65</td> <td>PN 4-105176</td> </tr> <tr> <td>BF5 Bushing D. 57</td> <td>PN 4-106570</td> </tr> </table>	BF1 Bushing D. 55	PN 4-105110	BF2 Bushing D. 58.1	PN 4-105174	BF3 Bushing D. 60.1	PN 4-105175	BF4 Bushing D. 65	PN 4-105176	BF5 Bushing D. 57	PN 4-106570	●	●	●		
BF1 Bushing D. 55	PN 4-105110																
BF2 Bushing D. 58.1	PN 4-105174																
BF3 Bushing D. 60.1	PN 4-105175																
BF4 Bushing D. 65	PN 4-105176																
BF5 Bushing D. 57	PN 4-106570																
8-21100161		<p>SL80 Pneumatic wheel lifter for wheel balancers.</p>	●	●	●												

OPTIONAL ACCESSORIES FOR B 55 AND B 60



PN	Picture	Description	B 55 M	B 55 AD	B 60 AD
8-21900210		BUK BASIC bike universal kit to balance motorcycle and scooter wheels; complete with SK14 code 8-21900228 (also suitable for Bravoline B35) *Motorcycle extension gauge not included	●	●	●
8-21900225		PRA5 Motorcycle extension gauge	●	●	●
8-21900226		SK10 Shaft kit \varnothing 10mm complete with clamping cones \varnothing 11-20 mm - \varnothing 11-20 mm, bushing and spacer L=150 mm	●	●	●
8-21900227		SK12 Shaft kit \varnothing 12mm complete with clamping cones \varnothing 13-24 mm , bushing and spacer L=250 mm	●	●	●
8-21900228		SK14 Shaft kit \varnothing 14mm complete with clamping cones \varnothing 15-25 mm - \varnothing 20-35 mm, bushing and spacer L=250 mm (supplied alsowith BUK BASIC code 8-21900210)	●	●	●
8-21900229		SK19 Shaft kit \varnothing 19mm complete with clamping cones \varnothing 21-51 mm, bushing and spacer L=300 mm	●	●	●
8-21900224		PRA6 Motorcycle extension gauge (for Bravoline B35)			

DIAGRAM OF PACKING SPECIFICATION

BRAVO LINE EQUIPMENT

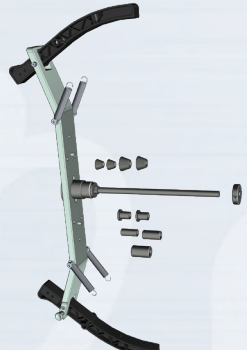

Model	Packing type	Dimensions (cm.) (A x B x H)	Net weight (kg)	Gross weight (kg)
PASSENGER CAR TYRE CHANGERS				
M 54 series	Wooden case (A)	115x195x100	225	295
M 51 series	"	125x108x110	245	285
M 34	"	115x92x105	240	270
M 31	"	105x81x99	180	205
HELPER 4FD (Disassembled arm)	Carton box on pallet (B)	53x120x42	70	110

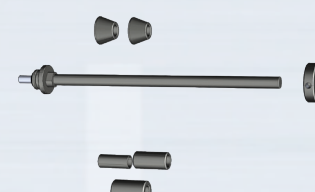
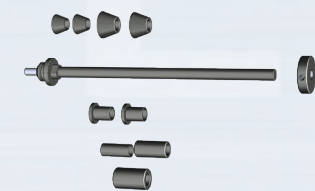
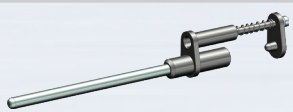
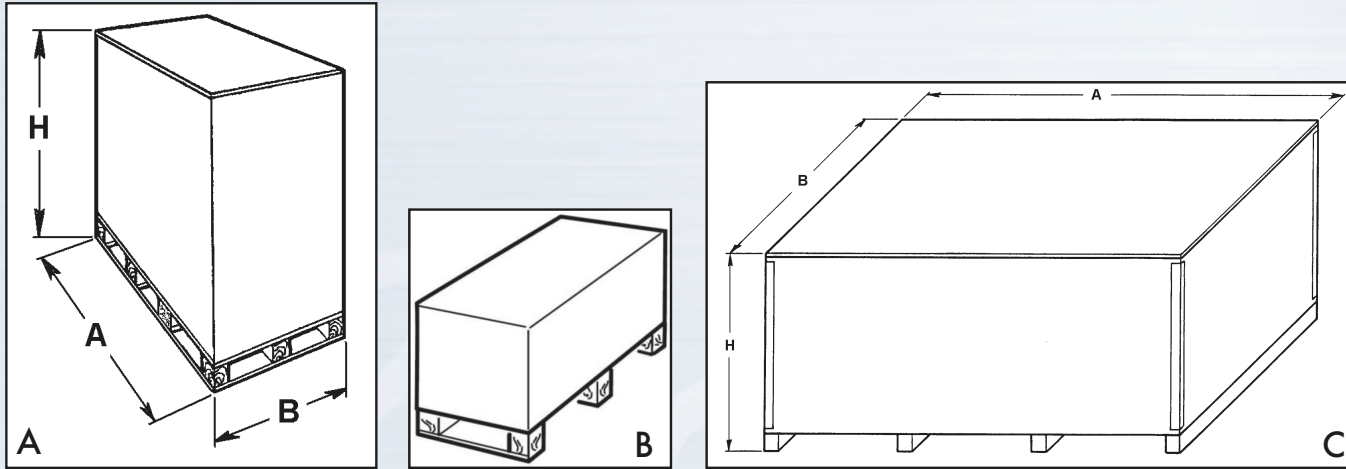
Model	Packing type	Dimensions (cm.) (A x B x H)	Net Weight (kg)	Gross Weight (kg)
HEAVY-DUTY TYRE CHANGERS				
F 440	Wooden case	230x210x110	980	1242
F 426	"	210x165x92	498	750

Model	Packing type	Dimensions (cm.) (A x B x H)	Net weight (kg)	Gross weight (kg)
WHEEL BALANCERS				
B 75 Truck	Wooden case (A)	165x90x120	235	300



**Bravo
LINE**

 : New or Modified Item

GENERAL SALE CONDITIONS

- The present export price-list, covering standard production equipment, replaces all previous ones.
- Goods are delivered FCA WAREHOUSE CORREGGIO - Incoterms® 2010, ICC Paris and shipped at buyer's cost.
- Standard packing is included in the price of each product.
- When ordering please always state model, quantity, power supply (Voltage, Phases, Hz) required.
- Terms of warranty: 12 months from installation date but no longer than 18 months from the date of NEXION S.p.A. invoice.
- The warranty does not cover defects or damages due to improper installation or use of products, inadequate maintenance or uncomplete knowledge of manuals supplied with the products.
- Any return of goods must always be authorized by NEXION S.p.A. and will be accepted only free our factory, custom cleared. Freight is at sender's risk.
- NEXION S.p.A. reserves the right to change the specifications of the products at any time without prior notice or obligation.

WARNING!

For other conditions please refer to the "Distribution Agreement".



**COMPANY WITH
CERTIFIED
QUALITY SYSTEM
- ISO 9001-**

